



RAYPAK REPLACEMENT INSTRUCTIONS

PC BOARD & TEMPERATURE CONTROL (KIT #013464F) FOR GAS POOL HEATERS WITH ELECTRONIC IGNITION (SEE "SCOPE" FOR MODELS)

IMPORTANT NOTICE

These instructions are intended for use by qualified personnel specifically trained and experienced in the installation of this type of heating equipment and related system components. Installation and service personnel may be required to be licensed in some states. Installation or repairs performed by unqualified persons may void the warranty.

DANGER - SHOCK HAZARD

Make sure electrical power to the heater is disconnected to avoid potential serious injury or damage to components.

DANGER - PROPANE HAZARD

Make sure to determine if unit is propane and see special instructions on page 6.

SCOPE:

This version of the temperature control board has an integrated ignition module plus 3-wire temperature sensor. It is a direct replacement for the following models: 185B, 206A, 207A, 265B, 266A, 267A, 268, 335B, 336A, 337A, 405B, 406A, 407A, 408.

MODELS

185B, 265B, 335B, 405B

PRODUCED NOV. 2003
THROUGH OCT. 2004

SERIAL # 0311 TO # 0410

This Kit Includes:

- (1) PC Control Board
- (1) LCD Gasket
- (5) Screws #6 x 3/8"
- (1) Remote Mode Label
- (1) Instructions

MODELS

**206A, 266A, 336A, 406A
207A, 267A, 337A, 407A
268, 408**

PRODUCED NOV. 2004
THROUGH CURRENT
SERIAL # 0411 TO CURRENT

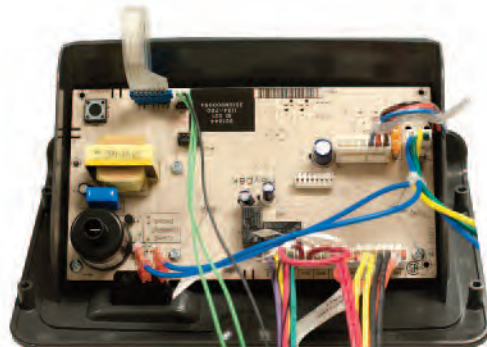

ACCESSING THE CONTROL BOARD

1. Turn off the power to the heater.
2. Turn off the gas to the heater.
3. B-Series: Remove front door by removing the 4 door panel screws shown in **Fig. 1** and **Fig. 2**.
4. A-Series: Remove front door by removing the large door screw in front of unit as shown in **Fig. 1**.
5. Remove the four screws on the side of control panel. See **Fig. 3** and **Fig. 4**.
6. Lay control panel forward toward you to access the back of the temperature control board.

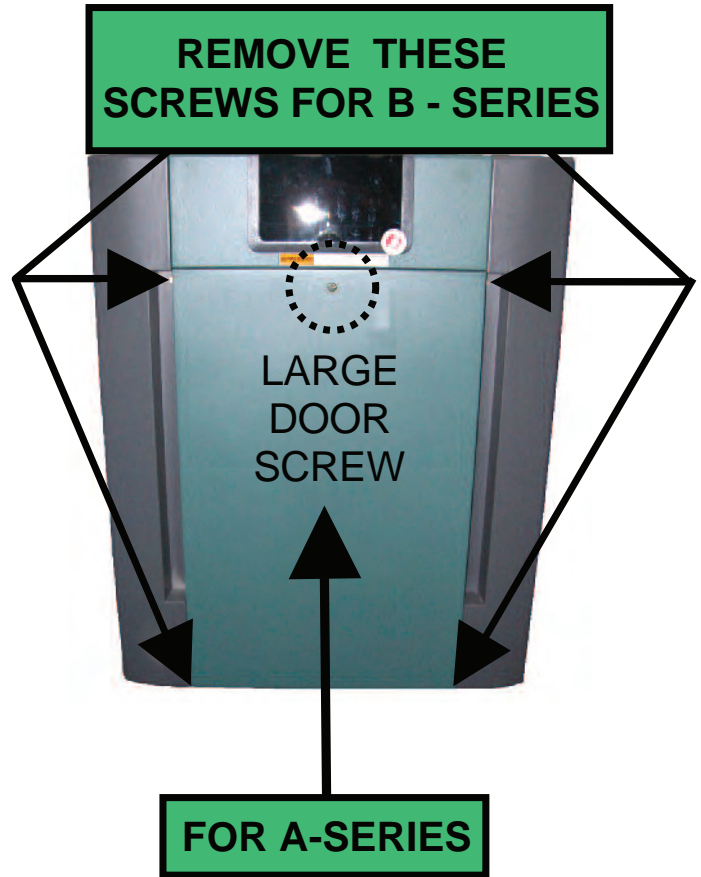

Fig. 1

Close-up



Fig. 2

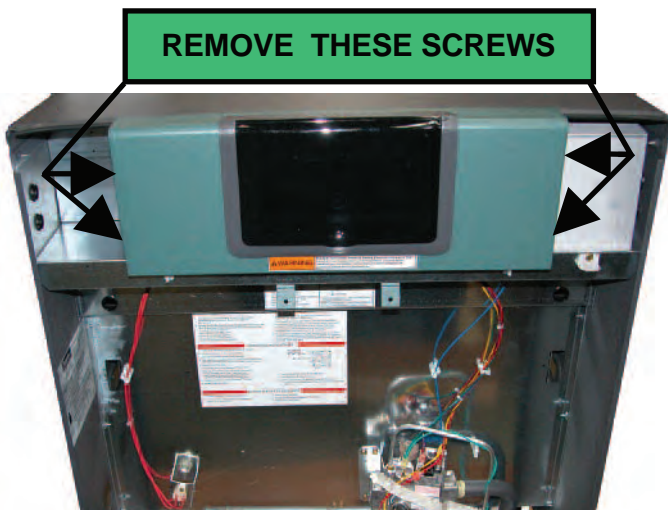

Fig. 3

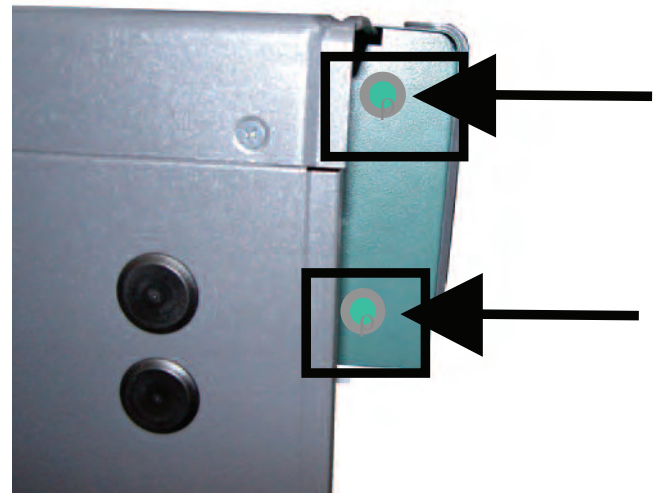

Fig. 4

REMOVING THE CIRCUIT BOARD

Make sure the power and gas are off.

1. Unplug all connectors from old circuit board. See **Fig. 5**.
2. Unplug keypad ribbon from old circuit board.
3. Remove screws as shown in **Fig. 6**.
4. Remove old circuit board.

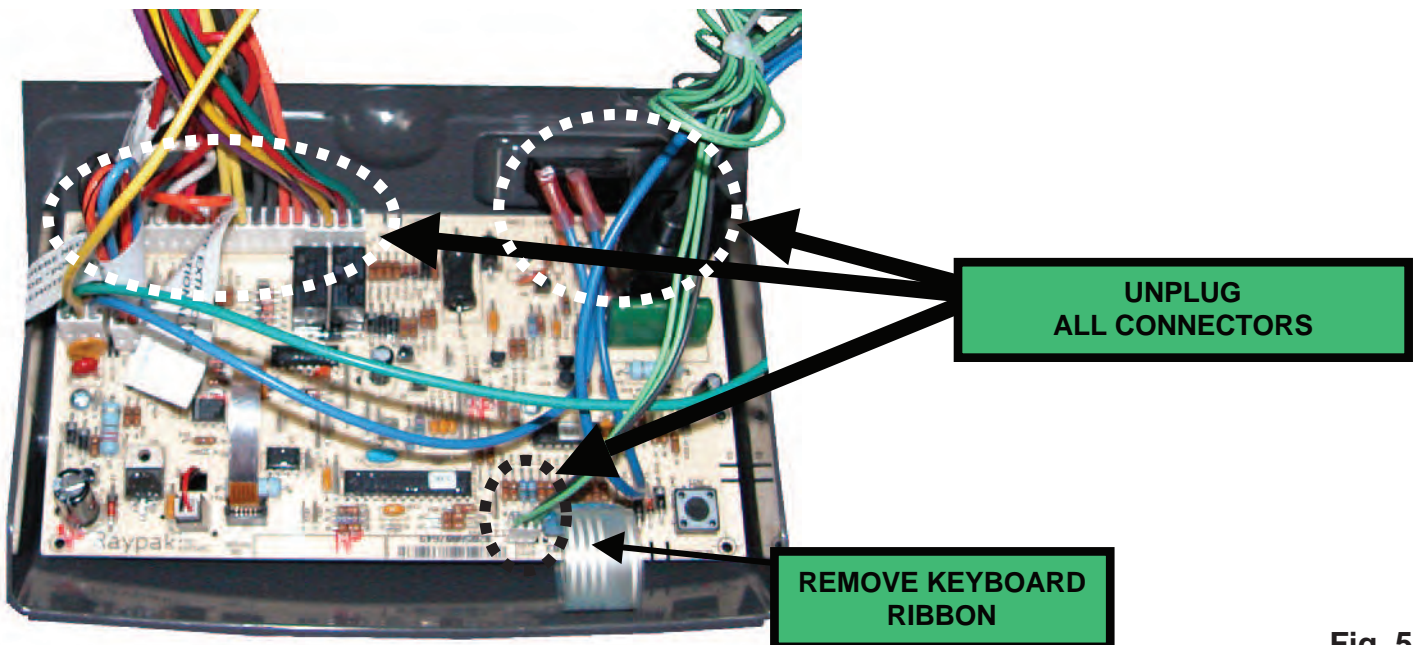

Fig. 5

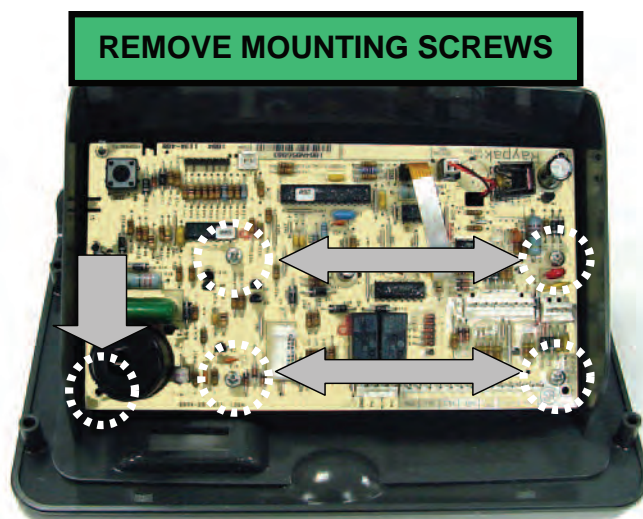

Fig. 6

**PROPANE HEATERS ONLY:
PREPARE NEW REPLACEMENT CONTROL PCB FOR INSTALLATION**

1. Locate the proper propane tab on the board as shown in Fig. 7.
2. Break off tab with pliers as shown in Fig. 8 & Fig. 9.

Note:

Requirements for Propane safety time vary by area. Check your local and state code regulations to determine whether your required Propane safety time is 15 seconds or 90 seconds.

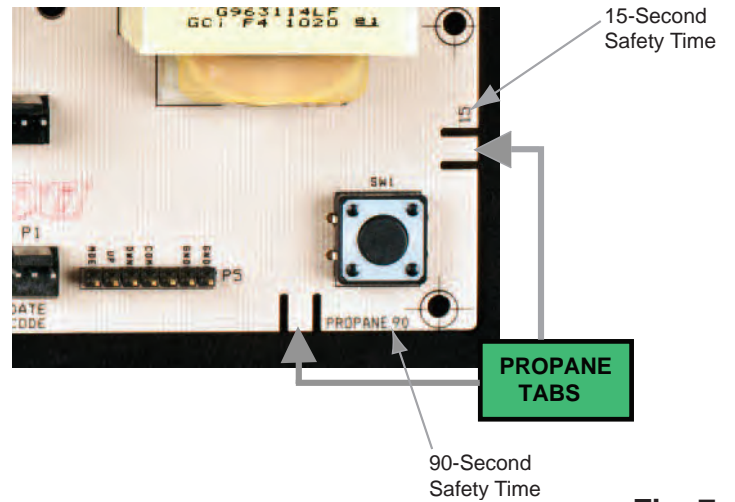

Fig. 7

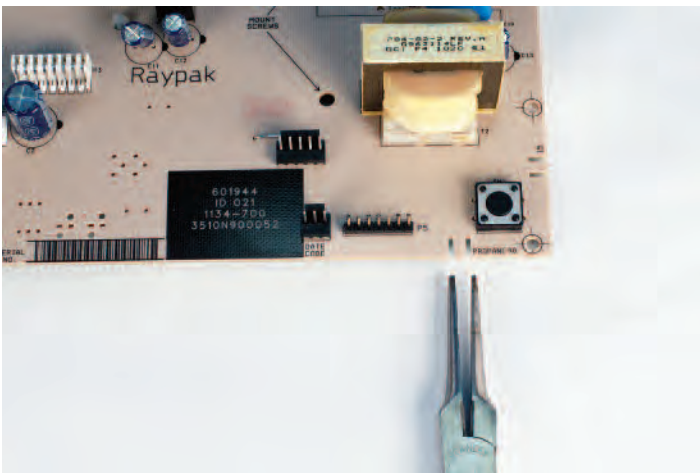

Fig. 8
90-second
safety time
shown

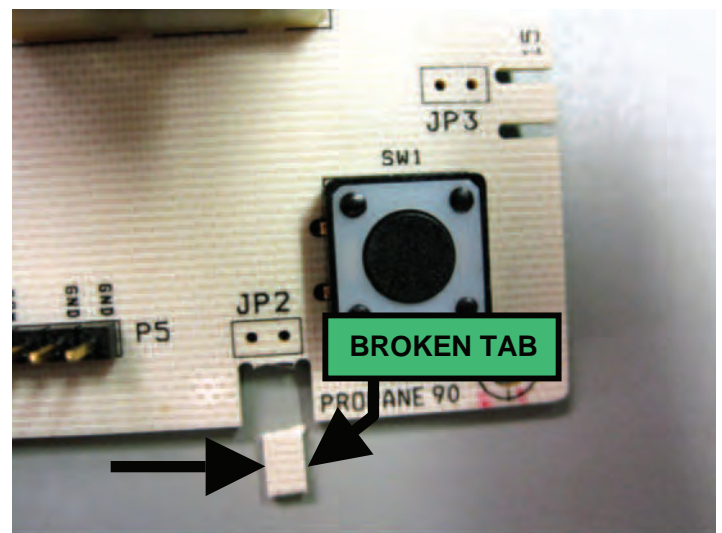

Fig. 9
90-second
safety time
shown

**MODELS 185B, 265B, 335B & 405B, Lo NOx ONLY:
PREPARE NEW REPLACEMENT CONTROL PCB FOR INSTALLATION**

1. DO NOT break tab See **Fig. 10** and **Fig. 11**.
2. No additional wiring or connections are necessary for Lo NOx operation.

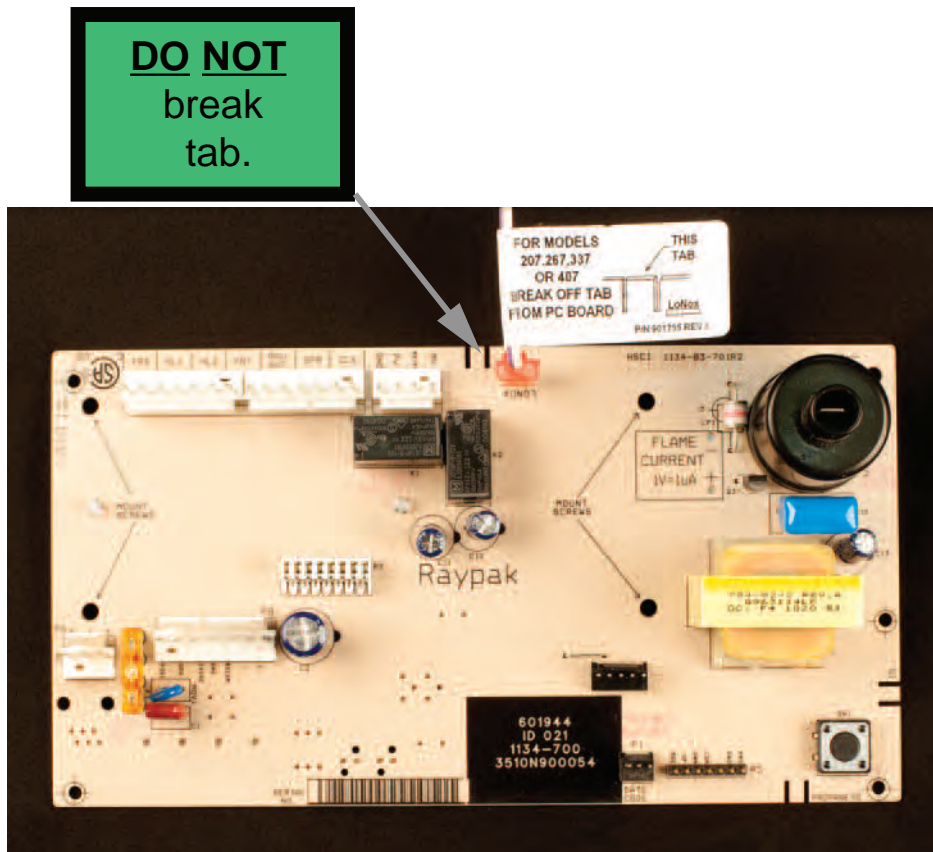

Fig. 10

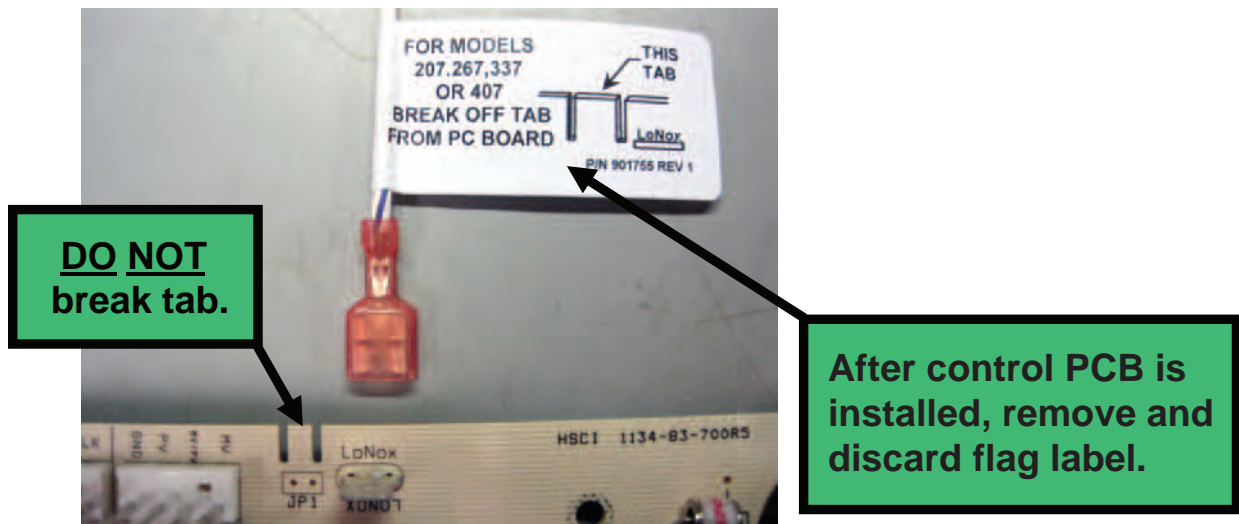

Fig. 11

**Lo NOx MODELS 207A, 267A, 337A & 407A ONLY:
PREPARE NEW REPLACEMENT CONTROL PCB FOR INSTALLATION**

1. Locate Lo NOx tab and P-10 air switch terminal on the board as shown in **Fig. 12** and **Fig. 13**.
2. Use pliers to break off the tab shown in **Fig. 14**.
3. Attach the wire from the air switch to the P-10 location shown in **Fig. 14**.

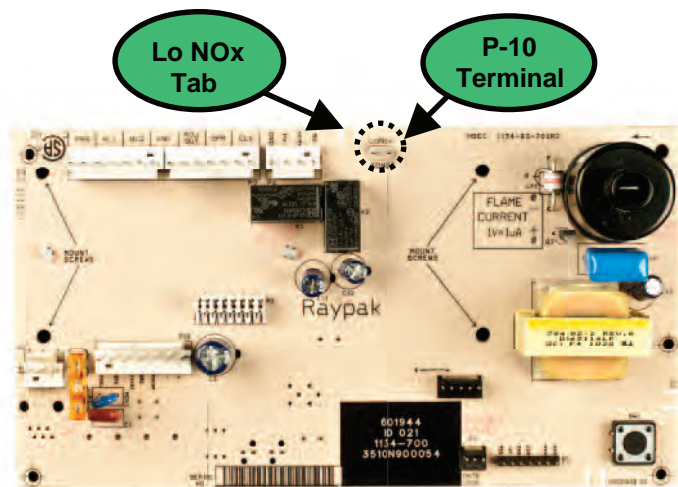

Fig. 12

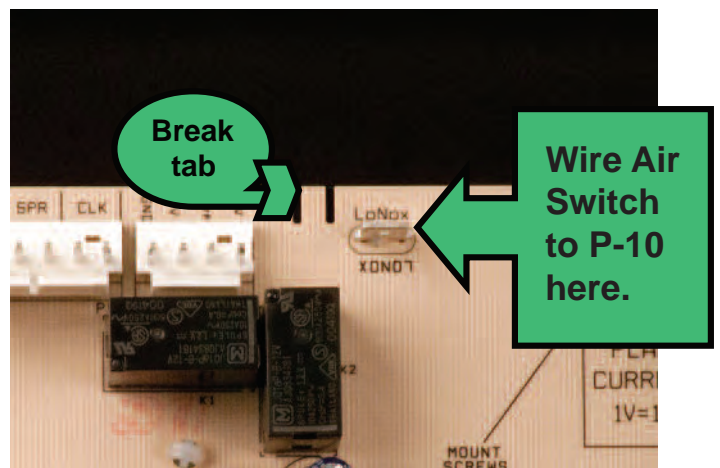

Fig. 13

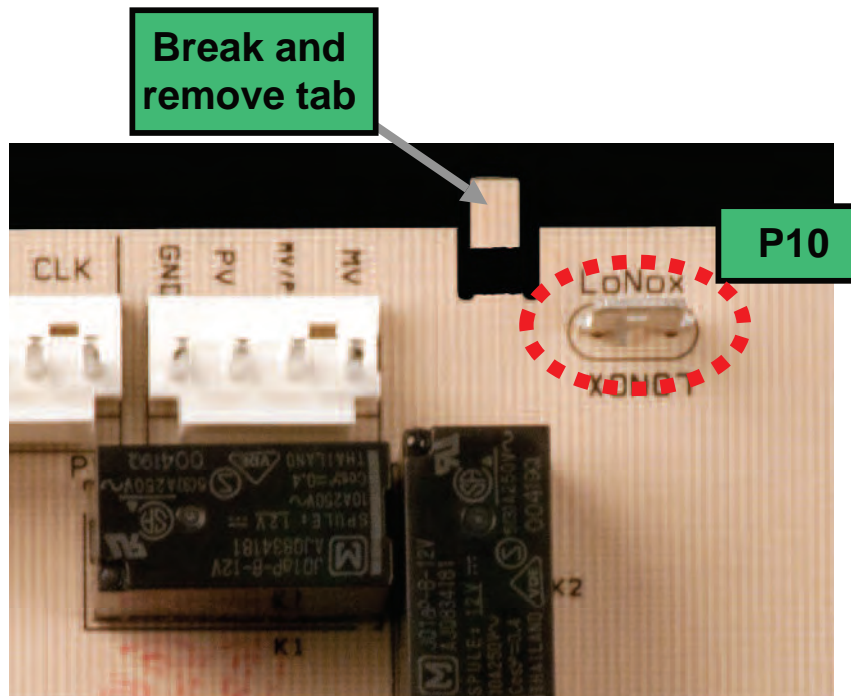

Fig. 14

GASKET INSTALLATION - ALL MODELS

1. If the existing bezel gasket is shorter than the new gasket included with this kit (see **Fig. 15**), remove the gasket completely from the bezel (**Fig. 16**).
2. Before removing the backing on the new gasket, verify the installation placement as per **Fig. 17**. The gasket is flexible and **MUST** be installed with all edges straight. Verify the fit before peeling the adhesive backing.



Fig. 15

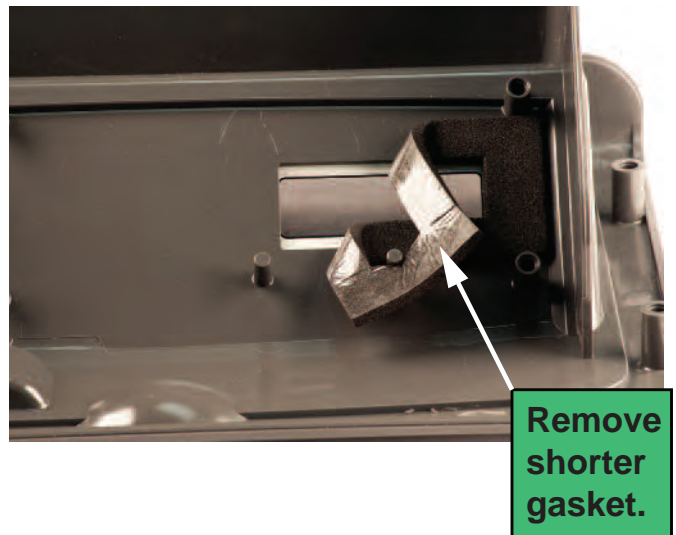

Fig. 16

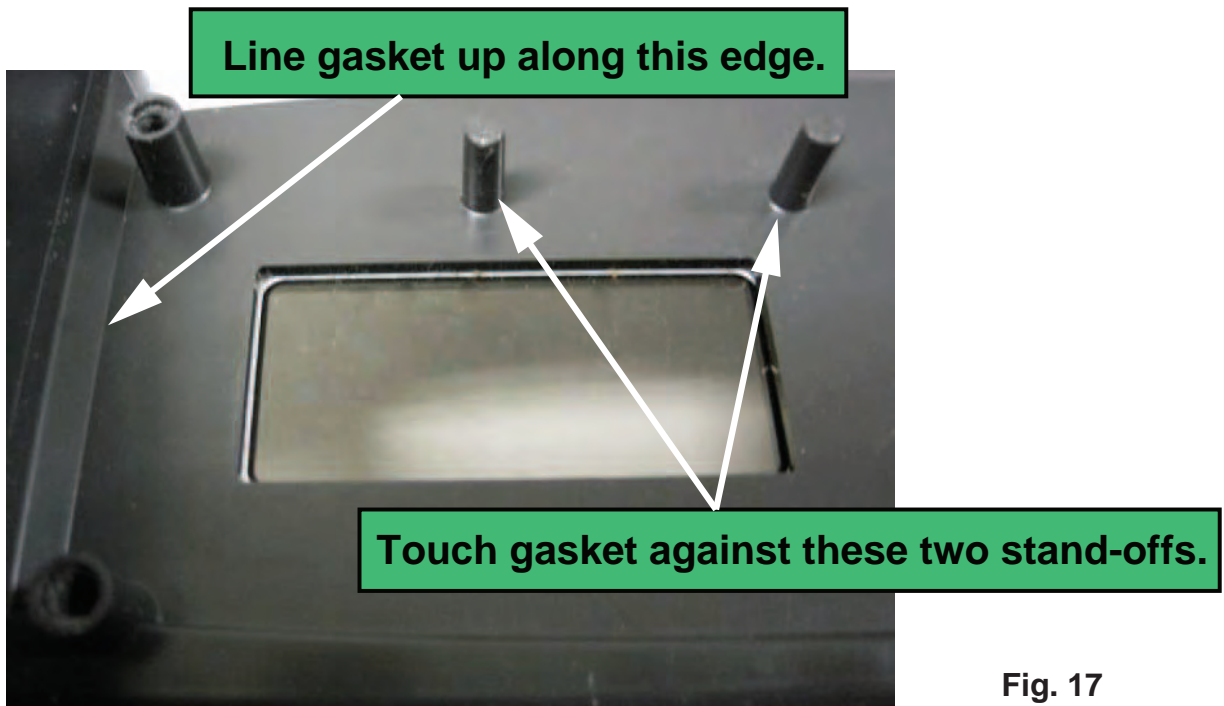

Fig. 17

GASKET INSTALLATION - ALL MODELS (Continued)

3. Remove the backing on the new gasket (**Fig. 18**) and install as per **Fig. 19**.

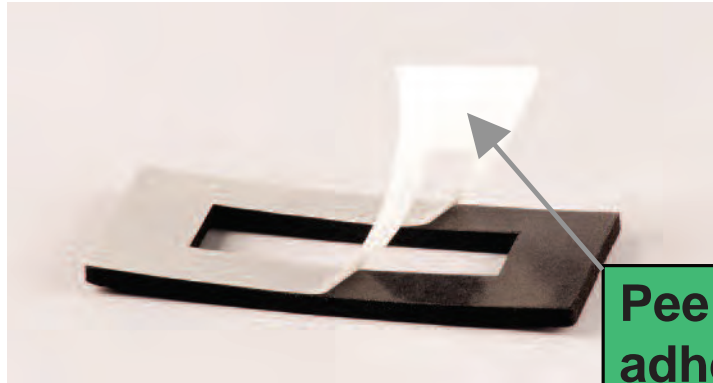

Fig. 18

**Peel
adhesive
backing.**

When the gasket is installed correctly, there will be a small part of the bezel showing within the display window area. The other side of the gasket will be even with the bezel display window edge.

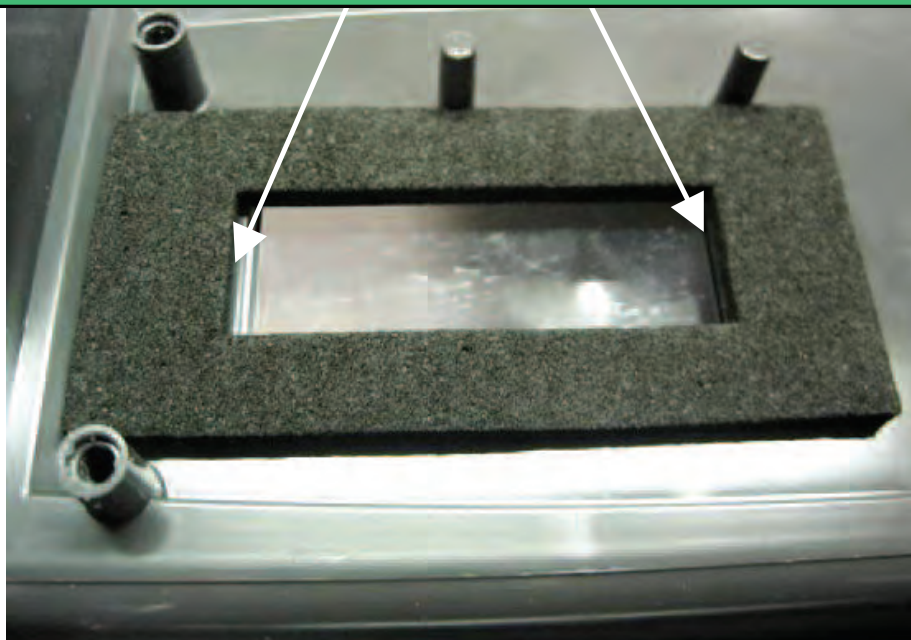

Fig. 19

REPLACEMENT CONTROL BOARD - ALL MODELS

1. Mount the replacement control board to plastic bezel using (5) five mounting screws as shown in **Fig. 20**.
2. Reconnect all cable connections. **WARNING:** See page 10 for specific directions on connecting P2 and P4.
3. When installation is complete, attach the new Remote Mode Label as shown in **Fig. 21**.

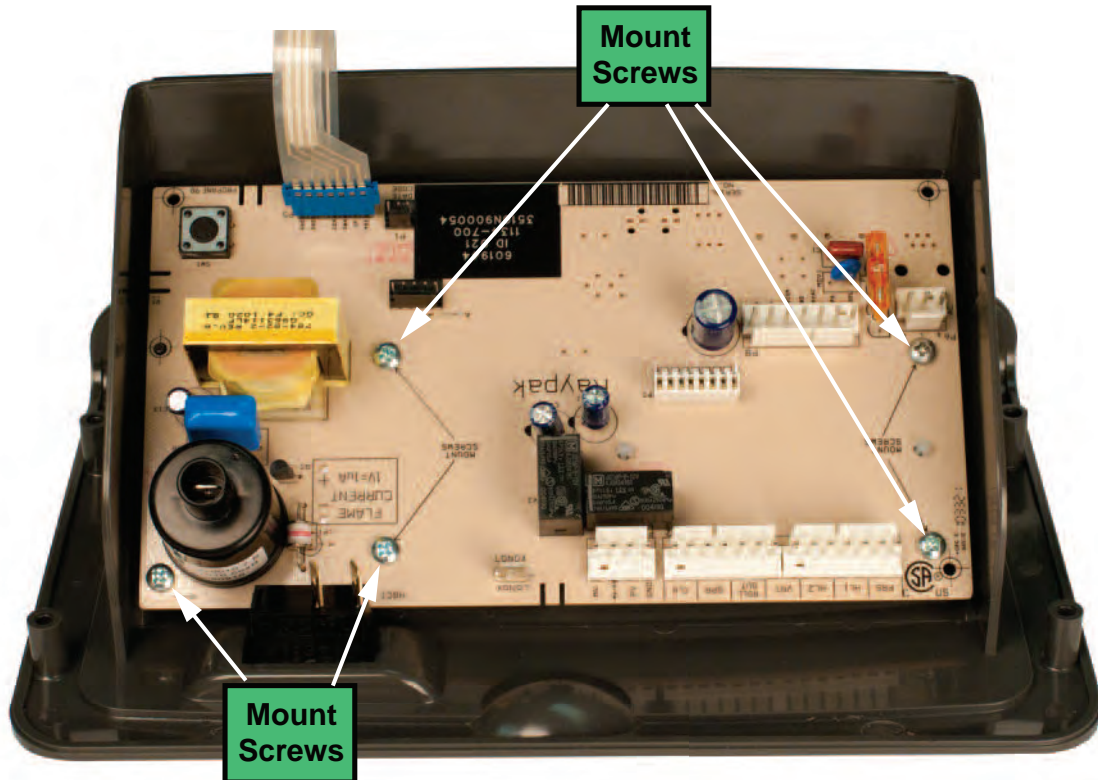

Fig. 20



Fig. 21

IMPORTANT

INSTALLING THE SAFETY AND GAS VALVE HARNESS ONTO P2 AND P4

Care must be taken when reinstalling the harness connections to P2 and P4.

The mating connections on the Advanced Flame Technology (AFT) board are rotated 180 degrees compared to the connections on the previous Digital board. See **Fig. 22** and **Fig. 23**.

Be sure the locking edge of the harness connector (**Fig. 24**) is oriented towards the board connector locking tabs when installing all Control PCB wire connectors.

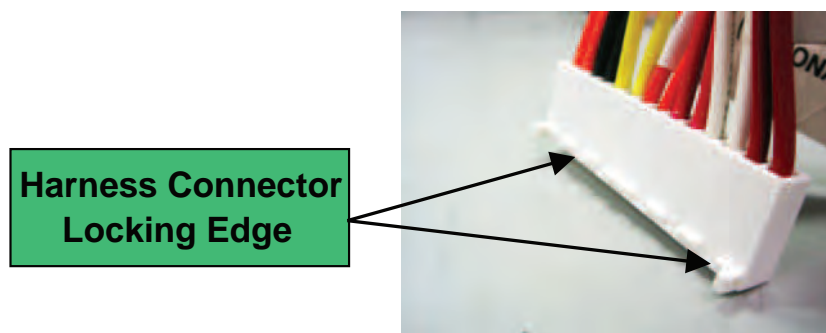
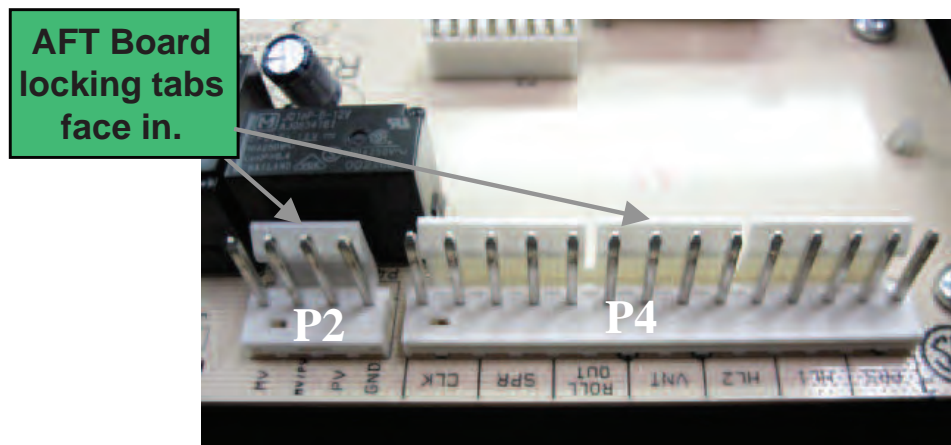
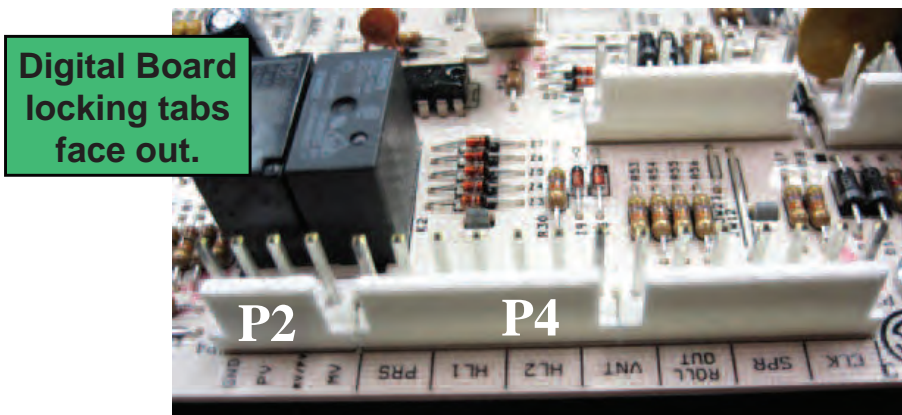

THERMOSTAT OPERATION - ADVANCED FLAME TECHNOLOGY (AFT) BOARD

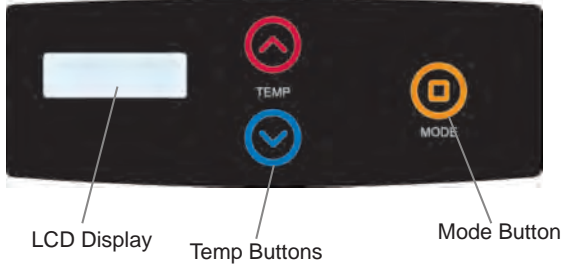

The pool heater touchpad, located on the upper front panel of the heater, allows the user to select either POOL or SPA operation, and to adjust the setpoint temperature. The LCD display window indicates the mode (OFF, SPA, POOL) and the actual water temperature. A manual power switch provided below the touchpad turns the control power ON or OFF.

Mode Button

The MODE button is used to select either POOL or SPA operation. It also allows the user to turn the heater off electronically, allowing the LCD display to remain energized and to continue showing the actual water temperature.

Temp Buttons

If the heater is in POOL or SPA mode, the desired water temperature (SETPOINT) will also be displayed and may be adjusted using the UP or DOWN buttons.

Operation

In the POOL or SPA modes, the actual water temperature is displayed along with the desired water temperature (SETPOINT). When the water temperature is above the setpoint, "Water Temp" will alternate with "No Demand." When the water temperature is below the setpoint and the heater is firing, "Water Temp" will alternate with "Heating."

To adjust the setpoint temperature, make sure the control is in the appropriate mode (POOL or SPA) and push the UP or DOWN buttons.

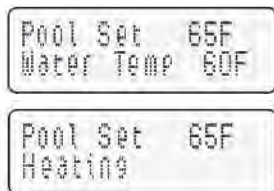

ALTERNATING DISPLAYS DURING HEATING

Service Menu and Fault History

To access the Service Menu and fault history, press the MODE and UP buttons simultaneously for 3 to 5 seconds. The heater will continue to operate normally while in the Service Menu. The first screen displayed is the Flame Strength indicator, which indicates the pilot flame current

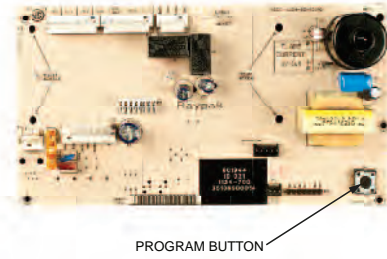

using a bar graph and numerical display. A signal of less than 4 indicates a weak flame signal and may require service. Refer to Section 5 – Troubleshooting for possible causes and corrections.



FLAME STRENGTH INDICATOR

Press the DOWN button. The Supply Voltage screen indicates the voltage supplied to the control board. Normal readings range from 24 to 29 volts.

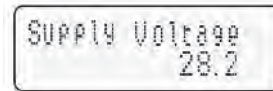

SUPPLY VOLTAGE INDICATOR

Press the DOWN button. The Run Time indicates the total hours of operation for the pool heater, as measured by the amount of time that the main gas valve has been powered. The Cycle count indicates the number of on/off cycles of the heater, as measured by the number of times the pilot valve has been powered.

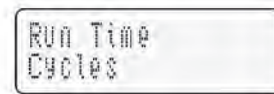

RUN TIME INDICATOR



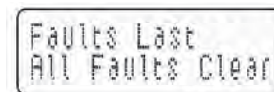

Press the DOWN button. The Fault History can display up to ten faults in memory. The order of the faults begins with "Fault Last," which is the most recent fault, and proceeds through ten most recent messages in chronological order. The second line of the display shows the fault message. If there are no faults in the history buffer, the second line reads "All Faults Clear."

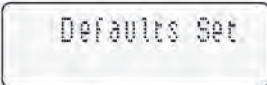

FAULT HISTORY

Program Button

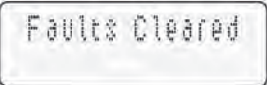
- 1) Remove the four screws holding the control cover, and swing the panel down so the back side of the board is visible (see page 2). Locate the Program Mode button (marked as SW1) as shown on page 15. Press and hold the button (5-7 seconds) until **Set Factory Defaults** appears on the display. Release the program button.
- 2) Press the **Mode** button sequentially until the desired program event is reached. There are 5 different events that can be programmed. They appear in the sequence listed below:

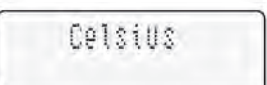
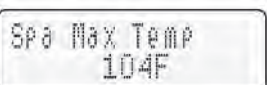
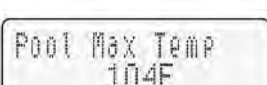
| | |
|---|---|
|  | Resets board to factory default settings. |
|  | |
|  | |
|  | Resets faults in the History File. |
|  | |
|  | Change from Fahrenheit to Celsius. |
|  | SPA setpoint maximum adjustment. |
|  | POOL setpoint maximum adjustment. |

Set Factory Defaults

Refer to step one above to access the program screen. **Set Factory Defaults** should appear on the screen. If it does not, press the **Mode** button until **Set Factory Defaults** appears on the digital display. Press and hold both UP and DOWN buttons for 5-7 seconds until **Defaults Set** appears. This operation resets the operating program to its factory default values. Both the POOL and SPA setpoints will revert to 65°F (18.5°C) and both POOL and SPA maximum temperature settings will be 104°F (40.0°C). The Control Lockout PIN will be cleared and the control will resume normal operation.

Clear Faults

Refer to step one above to access the program screen. Press the **Mode** button until **Clear Faults** appears on the digital display. Press and hold both UP and DOWN buttons for 5-7 seconds until **Faults Cleared** appears. This operation resets the Fault History file to "0" and clears all the stored faults.

Fahrenheit or Celsius

Refer to step one above to access the program screen. Press the **Mode** button until **Fahrenheit** or **Celsius** appears on the digital display. The digital display is capable of displaying Celsius as well as Fahrenheit temperatures. The UP or DOWN buttons will select **Fahrenheit** or **Celsius** on the temperature display. Choose the desired temperature scale.

Spa Max Temp – Spa Set Point Maximum Adjustment

Refer to step one above to access the program screen. Press the **Mode** button until **Spa Max Temp** appears on the digital display. Using the UP and DOWN buttons will change the Maximum Temperature Setting to your desired value. The control can be set for a maximum of 107°F.

Pool Max Temp – Pool Set Point Maximum Adjustment

Refer to step one above access into the program screen. Press the **Mode** button until **Pool Max Temp** appears on the digital display. Using the UP and DOWN buttons will change the Maximum Temperature Setting to your desired value. The control can be set for a maximum of 107°F.

Control Lockout

The heater is equipped with a Control Lockout feature to prevent unauthorized tampering or adjustment of the control settings. To lock out the controls, press the DOWN button and **Mode** button for 5 seconds. Choose a three digit PIN, using the UP and DOWN buttons to select the digits and the **Mode** button to lock in selections. Confirm your selection and record your PIN.

To unlock the controls, press any button to bring up the **Enter PIN** menu. Enter the PIN that was used to lock the control. Note that power cycling will **not** clear the lockout. Successfully unlocking the control will display "Lockout Cleared." Failure to enter the correct PIN will display "Invalid PIN."

In the event that the user-selected PIN is lost or does not clear the Control Lockout, use the Program Button to **Set Factory Defaults**. This will clear the PIN and allow normal operation and selection of a new PIN if desired. See the **Program Button** directions on this page for details.

NOTE: Both the POOL and SPA setpoints will revert back to 65°F (18.5°C) and the POOL and SPA maximum temperature settings will be 104°F (40.0°C). These setpoints will need to be readjusted to desired settings.

NOTE: The LCD temperature display may not agree with the temperature reading of your pool or spa thermometer. The heater reads the water temperature at the inlet. Due to the circulation characteristics of any pool or spa, the water temperature at the inlet to the heater may differ from that observed at a given location in the pool or spa.

STATUS AND DIAGNOSTICS

The digital thermostat models are programmed to display a variety of status and diagnostic messages, depending on the operating conditions.

The following heat status messages are displayed in Pool, Spa, and Remote modes when there are no active fault conditions.

| Display | Condition |
|-----------|--|
| Heating | Call for heat established, flame present |
| Spark | Spark operating |
| No Demand | Heat demand is satisfied |

The following conditions are displayed in Pool, Spa and Remote modes.

| Display | Condition |
|-------------------|---|
| Sensor Failure | Thermistor temperatures disagree by more than 2°F |
| Sensor Open | Thermistor sensor failed open. (Below -20°F) |
| Sensor Short | Thermistor sensor failed short. (Above 217°F) |
| Flame w/o CFH | Board is sensing flame when both main and pilot valves are commanded shut. |
| PV Output Fault | Pilot gas valve output is not in commanded state. |
| MV Output Fault | Main gas valve output is not in commanded state. |
| LoNox Tab Fault | Voltage is sensed at the Lo NOx terminal on a non-Lo NOx heater (Lo NOx tab is intact). |
| Internal Fault | Board fault, replace board. |
| EEPROM Fault | Memory fault, reset set points, replace board if fault does not clear. |
| Clock/ Fireman Sw | Time clock/fireman switch circuit is open. |
| Low Temp Lockout | Water temperature below 36°F. |

The following conditions are displayed only while there is a demand for heat present.

| Display | Condition |
|---|--|
| Water Sw Open | Water pressure switch open. |
| Vent/Field Sw #1 | Vent spill switch/field switch #1 open. |
| Hi Limit 1 Fault | High limit 1 open. |
| Hi Limit 2 Fault | High limit 2 open. |
| Rollout Sw Open | Rollout switch open. |
| Flow/Field SW #2 | Flow switch/field switch #2 open. |
| Fan Lockout | 3 fan switch faults within same heat demand cycle, power must be cycled to clear the fault. |
| Fan 5 Min Delay | Heater shut down for 5 minutes because LoNox fan switch didn't close. |
| Ignition Lockout (Propane Tab Broken) | Alternating with "No pilot sensed" - Pilot flame not established within the required time (15 sec or 90 sec). Alternating with "Main Ign Failure" - Pilot flame lost during the 8 second trial to ignite the main burner. |
| Ignition Failure (Propane Tab Not Broken) | Alternating with "No pilot sensed" - Pilot flame not established within 90 seconds. |
| Ign 6min Delay (Propane Tab Not Broken) | Alternating with "Main Ign Failure" - Pilot flame lost 4 times within the 8 second trial to ignite the main burner. Heater will lockout for 6 minutes before retrying. |

REMOTE CONTROL INSTALLATION AND OPERATION

CAUTION: Before installing remote controls to the AFT thermostat model heaters, read the following:

The digital thermostat model is remote-ready in most cases. The digital liquid crystal display (LCD) shows the actual pool temperature, operating status, and service codes (See examples below). The touch pad on the control panel allows you to select the desired pool or spa temperature. It also indicates when a remote system is controlling the heater by displaying **Remote** in the display. When connecting the heater to a remote system, identify whether it is a two- or three-wire remote system. Select the appropriate instruction listed below to properly install the remote to the heater.

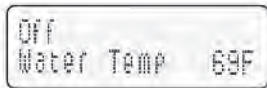

OFF Mode

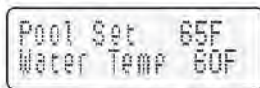

Heating in the POOL Mode

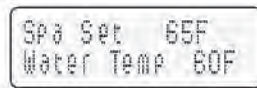

Heating in the SPA Mode



Remote Mode

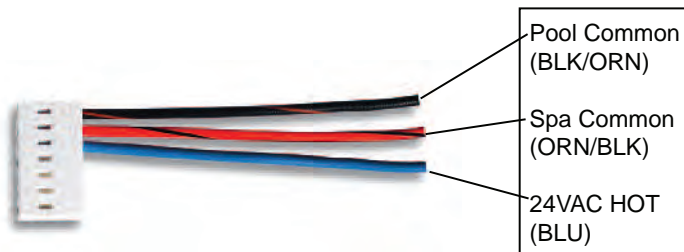
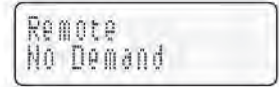
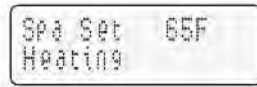
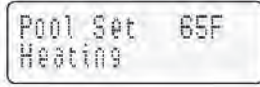

7-PIN Remote Wiring Connector

ACTIVATING THE REMOTE

To activate or deactivate the remote function, follow these steps:

Press and hold the UP and DOWN arrow buttons for 3 to 5 seconds.

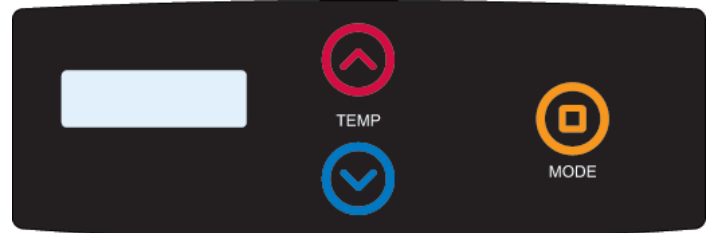

The second line of the display will alternate even when the unit is off ("No Demand").

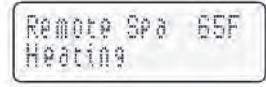
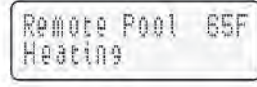
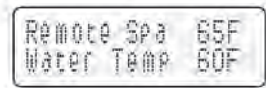

REMOTE OPERATION

The AFT model heaters are equipped with the ability to work with external remote controls. The supplied 7-pin remote wiring connector supplies power out to either a toggle switch or the switch contacts of a third party remote. The remote works by either making or breaking the circuit created by the remote wiring. Typically, a remote does not supply power to the heater, it only provides a switching function to turn the heater On or Off. **If your remote is supplying its own voltage to the heater, it will not work with this heater and may damage the digital circuit board.**

For operation of the heater using the onboard thermostatic controls with a time clock, see the "Time Clock / Fireman's Switch" section.

NOTE: When in remote operation, the keypad mode and temp buttons are disabled.



ATTENTION
OBSERVE PRECAUTIONS
ELECTROSTATIC SENSITIVE DEVICES

Note: Electrostatic Discharge (ESD) damage can be caused by direct or indirect contact with the wiring or circuit board. When one walks to the heater area, an electrostatic charge accumulates on the body. Contact of a finger allows the body to discharge, possibly causing device damage. This damage can be limited if the service person discharges himself, following ESD preventive/removal practices, and holds on to the heater enclosure for 5 seconds before proceeding.

REMOTE CONTROL WIRING

Important Installation Notes for Remote or External Wiring Configuration

- Remote wiring must be run in a separate conduit.
- Remote wiring must not be run parallel to high voltage lines.
- For runs of under 30 feet, remote wiring should have stranded conductors with a minimum of 22 AWG, 600V, cable twisting 1.5 to 2.5 in. lay and jacketed.
- For runs over 30 feet, the conductors should be a minimum of 20 AWG, 600V, cable twisting 1.5 to 2.5 inch lay that is shielded and jacketed.
- Maximum cable length is 200 feet.
- For both two- and three-wire remote systems, the provided 7-pin wiring connector must be utilized. Please refer to the wiring instructions.

NOTE: The remote wires must be connected to the 7-pin connector **before** the connector is plugged into the board.

2-Wire Remote Control (On-Off)

This application assumes that only one heating function (pool or spa) is required.

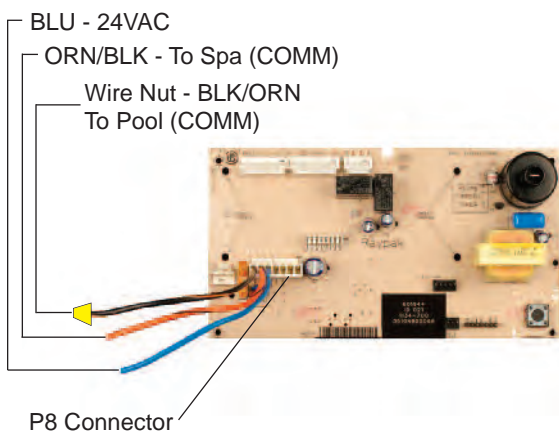

1. Turn on power to the heater.
2. For a 2-Wire Remote Control from a remote without its own sensor, push the mode button to the "POOL" or "SPA" mode and set the desired setpoint (eg. 102 °F for spa).
3. For a 2-Wire Remote Control from a remote with its own sensor, push the mode button "POOL" or "SPA" mode and set the temperature to the highest setting available on the control. The actual setpoint will be controlled by the remote control.
4. Turn the mode button to "OFF" and remove power from the heater.
5. On the "Remote Interface Harness", connect the BLUE wire to one side of the "REMOTE" switch and connect the other side to either the ORANGE/BLACK wire for "SPA" operation or the BLACK/ORANGE wire for "POOL" operation.
6. Attach wire nut on unused wire to the "Remote Interface Harness."
7. Install the "7-Pin Remote Interface Harness" to the P8 connector and turn power "On" to the heater.

See instructions on previous page to activate the remote control.

3-Wire Remote Control Using Three-Position Switch (Pool-Off-Spa, or Low-Off-High)

This application assumes that both heating functions (pool and spa) are required.

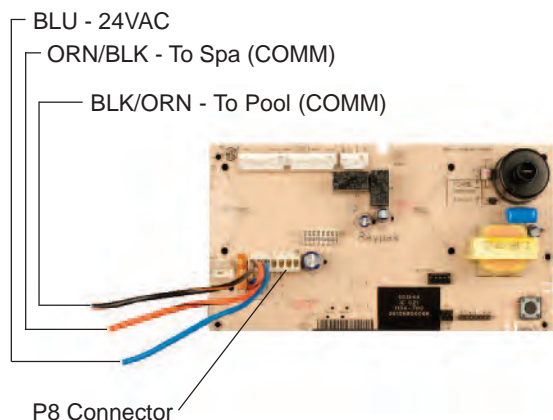

1. Turn on power to the heater.
2. Push the mode button to the "POOL" or "SPA" mode and set the desired temperature for each (eg. 80°F for Pool and 102°F for Spa).
3. Turn the mode button to "OFF" and remove power from the heater.
4. On the "Remote Interface Harness" connect the BLUE wire to one side of the "REMOTE" switch and connect the ORANGE/BLACK wire for "SPA" operation and the BLACK/ORANGE wire for the "POOL" operation.
5. Install the "Remote Interface Harness" to the P8 connector and turn power "ON" to the heater.

See instructions on previous page to activate the remote control.



2151 Eastman Ave., Oxnard, CA 93030 (805) 278-5300 FAX: (805) 278-5468